

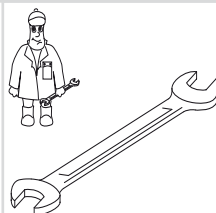

Gebr. Becker GmbH
Hölker Feld 29-31
D-42279 Wuppertal



Wartung
Maintenance
Entretien
Manutenzione
Mantenimiento

	Pos.	Menge ²⁾ Quantity Quantité Quantità Cantidad	Bestell-Nr. Ident No. No. Identification No. Identificazione No. de pedido	Bezeichnung Description Designation Designazione Descripción
T 4.25DSK	24	SATZ (KIT)	901349 00007	Schieber, Rotor Vane, Palette, Empujador
	72	1	909505 00000	Filterpatrone, Filter cartridge, Cartouche Filtrante, Cartuccia filtro, Cartucho de filtro
	73	1	909518 00000	Filterpatrone, Filter cartridge, Cartouche Filtrante, Cartuccia filtro, Cartucho de filtro
	74	1	909529 00000	Filterpatrone, Filter cartridge, Cartouche Filtrante, Cartuccia filtro, Cartucho de filtro
T 4.40DSK	24	SATZ (KIT)	901352 00007	Schieber, Rotor Vane, Palette, Empujador
	72	1	909505 00000	Filterpatrone, Filter cartridge, Cartouche Filtrante, Cartuccia filtro, Cartucho de filtro
	73	1	909518 00000	Filterpatrone, Filter cartridge, Cartouche Filtrante, Cartuccia filtro, Cartucho de filtro
	74	1	909529 00000	Filterpatrone, Filter cartridge, Cartouche Filtrante, Cartuccia filtro, Cartucho de filtro

²⁾ erforderliche Bestellmenge / necessary order quantity / quantité nécessaire / quantità di ordinazione necessari / cantidad necesario



Ersatzteilliste
Spare parts list
Liste de pièces de rechange
Listino pezzi di ricambio
Lista de piezas de recambio
Lista de peças sobresselentes
Reserveonderdelenlijst
Reservedelsliste
Reservdelista

Reservedelsliste
Varaosaluettelo
Wykaz części zamiennych
Seznam náhradních dílů
Tartalékalkatrész lista
Κατάλογος ανταλλακτικών
Перечень запасных частей
备用零件目录
スペアパーツリスト

T 4.25DSK
T 4.40DSK



28000027503 04/2007

Index-A

 SERVICE	 D-42279 Wuppertal www.becker-international.com	year <input type="text" value="XXXX"/>	Index Option
	No. <input type="text" value="A"/>	type <input type="text" value="T 4.25DSK-XX"/>	
CE	frequency <input type="text" value="XXXX"/> Hz	speed <input type="text" value="XXXX"/> min ⁻¹	Made in <input type="radio"/> Germany
power required <input type="text" value="XXXX"/> kW	inlet capacity <input type="text" value="XXXX"/> m ³ /h	pressure + <input type="text" value="XXXX"/> mbar	
vacuum - <input type="text" value="XXXX"/> mbar			

(D) Service:
Tel: +49 (0)202 697-171
Fax: +49 (0)202 64 44 74
E-Mail: info@becker-international.com
 www.becker-international.com



T 4.25DSK

Pos.	Bestell Nr.	Beschreibung	
15	020000 16400	KOLBEN	
16	016800 16500	SPANNSCHEIBE	
17	911012 00000	STAR-TOLERANZRING	
18	949203 00000	ZAHNSCHEIBE	
19	945320 00000	INNENSECHSKANTSCHRAUBE	
21	000100 27500	GEHÄUSE	
22	951806 00000	SPANNHÜLSE	
23	945320 00000	INNENSECHSKANTSCHRAUBE	
24	901349 00007	SCHIEBER, KOHLE (SATZ)	
25	952009 00000	SPANNHÜLSE	
28	000700 27600	SEITENDECKEL	
29	945373 00000	INNENSECHSKANTSCHRAUBE	
30	008900 16500	DICHTUNG	
31	948763 00000	KERBNAGEL	
32	953114 00000	SCHALLDÄMPFERDÜSE	
33	560200 27500	KÜHLER	
34	005700 27600	DICHTUNG	
35	945325 00000	INNENSECHSKANTSCHRAUBE	
46	502300 16400	VENTILATOR	
48	947713 00000	PASSFEDER	
49	949454 00000	UNTERLEGSCHNEIBE	
50	901804 00000	WELLENENDSCHRAUBE	
61	004803 27600	FILTERDECKEL	
67	009000 16300	ANPRESSFEDER	
72	909505 00000	FILTERPATRONE C 75/2 (1x) ¹⁾	
73	909518 00000	FILTERPATRONE C 44 (1x) ¹⁾	
74	909529 00000	FILTERPATRONE C78/6 (1x) ¹⁾	
76	945373 00000	INNENSECHSKANTSCHRAUBE	
77	948021 00000	DICHTRING	
78	913161 00000	O-RING	
83	006800 27500	GERÄTEHAUBE	
84	742609 01000	SCHLAUCH	
85	951920 00000	GUMMIFORMTEIL	
88	006803 27600	GERÄTEHAUBE	
89	741365 00000	GUMMIPUFFER	
90	945318 00000	INNENSECHSKANTSCHRAUBE	
91	951922 00000	GUMMIFORMTEIL	
92	964108 00000	KANTENSCHUTZ	
94	015100 27600	FUSS	
95	951921 00000	GUMMIFORMTEIL	
96	068000 27600	DISTANZSTÜCK	
97	945328 00000	INNENSECHSKANTSCHRAUBE	
98	949451 00000	UNTERLEGSCHNEIBE	
101	833903 99597	VENTILTeller	
102	951906 00000	KABELTÜLLE	
103	068002 16500	DISTANZROHR	
104	548800 16300	RINGSCHRAUBE	
124	736000 99613	VAKUUMREGULIERVENTIL	
125	728002 99611	DRUCKREGULIERVENTIL	

¹⁾ erforderliche Bestellmenge / Wartung

T 4.25DSK (1~) Ausführung - Einphasenwechselstrom

Abweichende Positionen zum Standardgerät - siehe Anhang (Zeichnungsrückseite)

OPTIONAL



T 4.40DSK

Pos.	Bestell Nr.	Beschreibung	
15	020000 16500	KOLBEN	
16	016800 16500	SPANNSCHEIBE	
17	911008 00000	STAR-TOLERANZRING	
18	949203 00000	ZAHNSCHEIBE	
19	945320 00000	INNENSECHSKANTSCHRAUBE	
21	000100 27600	GEHÄUSE	
22	951806 00000	SPANNHÜLSE	
23	945322 00000	INNENSECHSKANTSCHRAUBE	
24	901352 00007	SCHIEBER, KOHLE (SATZ)	
25	952009 00000	SPANNHÜLSE	
28	000700 27600	SEITENDECKEL	
29	945374 00000	INNENSECHSKANTSCHRAUBE	
30	008900 16500	DICHTUNG	
31	948763 00000	KERBNAGEL	
32	953114 00000	SCHALLDÄMPFERDÜSE	
33	560200 27600	KÜHLER	
34	005700 27600	DICHTUNG	
35	945325 00000	INNENSECHSKANTSCHRAUBE	
46	902300 27600	VENTILATOR	
48	947713 00000	PASSFEDER	
49	949454 00000	UNTERLEGSCHNEIBE	
50	901804 00000	WELLENENDSCHRAUBE	
61	004803 27600	FILTERDECKEL	
67	009000 16300	ANPRESSFEDER	
72	909505 00000	FILTERPATRONE C 75/2 (1x) ¹⁾	
73	909518 00000	FILTERPATRONE C 44 (1x) ¹⁾	
74	909529 00000	FILTERPATRONE C78/6 (1x) ¹⁾	
76	945373 00000	INNENSECHSKANTSCHRAUBE	
77	948021 00000	DICHTRING	
78	913161 00000	O-RING	
83	006800 27600	GERÄTEHAUBE	
84	742609 01000	SCHLAUCH	
85	951920 00000	GUMMIFORMTEIL	
88	006803 27600	GERÄTEHAUBE	
89	741365 00000	GUMMIPUFFER	
90	945318 00000	INNENSECHSKANTSCHRAUBE	
91	951922 00000	GUMMIFORMTEIL	
92	964108 00000	KANTENSCHUTZ	
94	015100 27600	FUSS	
95	951921 00000	GUMMIFORMTEIL	
96	068000 27600	DISTANZSTÜCK	
97	945328 00000	INNENSECHSKANTSCHRAUBE	
98	949451 00000	UNTERLEGSCHNEIBE	
101	833903 99597	VENTILTeller	
102	951906 00000	KABELTÜLLE	
103	068002 16500	DISTANZROHR	
104	548800 16300	RINGSCHRAUBE	
124	736000 99613	VAKUUMREGULIERVENTIL	
125	728002 99611	DRUCKREGULIERVENTIL	

¹⁾ erforderliche Bestellmenge / Wartung

T 4.40DSK (1~) Ausführung - Einphasenwechselstrom

T 4.40DSK-34 (3~) Sonderausführung - mit vergrößerter Exzentrizität

Abweichende Positionen zum Standardgerät - siehe Anhang (Zeichnungsrückseite)

OPTIONAL



T 4.25DSK

Pos.	Ident No.	Description
15	020000 16400	ROTOR
16	016800 16500	CLAMPING DISC
17	911012 00000	STAR-TOLERANCE-RING
18	949203 00000	TOOTHED SPRING WASHER
19	945320 00000	SOCKET HEAD SCREW
21	000100 27500	PUMP BODY
22	951806 00000	LOCATING PEG
23	945320 00000	SOCKET HEAD SCREW
24	901349 00007	CARBON VANES (KIT)
25	952009 00000	LOCATING PEG
28	000700 27600	LID
29	945373 00000	SOCKET HEAD SCREW
30	008900 16500	GASKET
31	948763 00000	SLOTTED PIN
32	953114 00000	NOZZLE
33	560200 27500	COOLER
34	005700 27600	GASKET
35	945325 00000	SOCKET HEAD SCREW
46	502300 16400	FAN
48	947713 00000	KEY
49	949454 00000	WASHER
50	901804 00000	SHAFT END BOLD
61	004803 27600	FILTER COVER
67	009000 16300	LEAF SPRING
72	909505 00000	FILTER CARTRIDGE C 75/2 (1x)¹⁾
73	909518 00000	FILTER CARTRIDGE C 44 (1x)¹⁾
74	909529 00000	FILTER CARTRIDGE C78/6 (1x)¹⁾
76	945373 00000	SOCKET HEAD SCREW
77	948021 00000	SEALING RING
78	913161 00000	O-RING
83	006800 27500	PROTECTING HOOD
84	742609 01000	TUBE FLEXIBLE
85	951920 00000	RUBBER ELEMENT
88	006803 27600	PROTECTING HOOD
89	741365 00000	RUBBER BUFFER
90	945318 00000	SOCKET HEAD SCREW
91	951922 00000	RUBBER ELEMENT
92	964108 00000	EDGE PROTECTION
94	015100 27600	FOOT
95	951921 00000	RUBBER ELEMENT
96	068000 27600	SPACING COLLAR
97	945328 00000	SOCKET HEAD SCREW
98	949451 00000	WASHER
101	833903 99597	VALVE DISC
102	951906 00000	RUBBER BUSHING
103	068002 16500	SPACER TUBE
104	548800 16300	RING SCREW
124	736000 99613	VACUUM REGULATING VALVE
125	728002 99611	PRESSURE REGULATING VALVE

¹⁾ necessary order quantity / maintenance

T 4.25DSK (1~) Design - single-phase AC

Items different from standard appliance see appendix (back of drawing)



T 4.40DSK

Pos.	Ident No.	Description
15	020000 16500	ROTOR
16	016800 16500	CLAMPING DISC
17	911008 00000	STAR-TOLERANCE-RING
18	949203 00000	TOOTHED SPRING WASHER
19	945320 00000	SOCKET HEAD SCREW
21	000100 27600	PUMP BODY
22	951806 00000	LOCATING PEG
23	945322 00000	SOCKET HEAD SCREW
24	901352 00007	CARBON VANES (KIT)
25	952009 00000	LOCATING PEG
28	000700 27600	LID
29	945374 00000	SOCKET HEAD SCREW
30	008900 16500	GASKET
31	948763 00000	SLOTTED PIN
32	953114 00000	NOZZLE
33	560200 27600	COOLER
34	005700 27600	GASKET
35	945325 00000	SOCKET HEAD SCREW
46	902300 27600	FAN
48	947713 00000	KEY
49	949454 00000	WASHER
50	901804 00000	SHAFT END BOLD
61	004803 27600	FILTER COVER
67	009000 16300	LEAF SPRING
72	909505 00000	FILTER CARTRIDGE C 75/2 (1x)¹⁾
73	909518 00000	FILTER CARTRIDGE C 44 (1x)¹⁾
74	909529 00000	FILTER CARTRIDGE C78/6 (1x)¹⁾
76	945373 00000	SOCKET HEAD SCREW
77	948021 00000	SEALING RING
78	913161 00000	O-RING
83	006800 27600	PROTECTING HOOD
84	742609 01000	TUBE FLEXIBLE
85	951920 00000	RUBBER ELEMENT
88	006803 27600	PROTECTING HOOD
89	741365 00000	RUBBER BUFFER
90	945318 00000	SOCKET HEAD SCREW
91	951922 00000	RUBBER ELEMENT
92	964108 00000	EDGE PROTECTION
94	015100 27600	FOOT
95	951921 00000	RUBBER ELEMENT
96	068000 27600	SPACING COLLAR
97	945328 00000	SOCKET HEAD SCREW
98	949451 00000	WASHER
101	833903 99597	VALVE DISC
102	951906 00000	RUBBER BUSHING
103	068002 16500	SPACER TUBE
104	548800 16300	RING SCREW
124	736000 99613	VACUUM REGULATING VALVE
125	728002 99611	PRESSURE REGULATING VALVE

¹⁾ necessary order quantity / maintenance

T 4.40DSK (1~) Design - single-phase AC

T 4.40DSK-34 (3~) Special design - with enlarged eccentricity

Items different from standard appliance see appendix (back of drawing)



OPTIONAL

OPTIONAL



T 4.25DSK

Pos.	No. Identification	Designation
15	020000 16400	PISTON
16	016800 16500	DISQUE DE SERRAGE
17	911012 00000	BAGUE STAR
18	949203 00000	DENT DISQUE
19	945320 00000	VIS HEXAGONALE INTERNE
21	000100 27500	CORP DE POMPE
22	951806 00000	DOUILLE DE ETRAGE
23	945320 00000	VIS HEXAGONALE INTERNE
24	901349 00007	PALETTE DE CHARBON (KIT)
25	952009 00000	DOVILLE DE ETRAGE
28	000700 27600	COUVERCLE
29	945373 00000	VIS HEXAGONALE INTERNE
30	008900 16500	JOINT
31	948763 00000	GOUPILLE A ENCOCHE
32	953114 00000	BUSE
33	560200 27500	REFROIDISSEUR
34	005700 27600	JOINT
35	945325 00000	VIS HEXAGONALE INTERNE
46	502300 16400	VENTILATEUR
48	947713 00000	CLAVETTE
49	949454 00000	RONDELLE
50	901804 00000	VIS BOUT D'ARBRE
61	004803 27600	COUVERCLE DU FILTRE
67	009000 16300	RESSORT-JAME
72	909505 00000	CARTOUCHE FILTRANTE C 75/2 (1x) ¹⁾
73	909518 00000	CARTOUCHE FILTRANTE C 44 (1x) ¹⁾
74	909529 00000	CARTOUCHE FILTRANTE C78/6 (1x) ¹⁾
76	945373 00000	VIS HEXAGONALE INTERNE
77	948021 00000	JOINT
78	913161 00000	ANNEAU-O
83	006800 27500	CARTER PROTECTEUR
84	742609 01000	TUBE FLEXIBLE
85	951920 00000	ELEMENT EN CAOUTCHOUC
88	006803 27600	CARTER PROTECTEUR
89	741365 00000	AMORTISSEUR EN CAOUTCHOUC
90	945318 00000	VIS HEXAGONALE INTERNE
91	951922 00000	ELEMENT EN CAOUTCHOUC
92	964108 00000	PROTECTION D'ARETE
94	015100 27600	PIED
95	951921 00000	ELEMENT EN CAOUTCHOUC
96	068000 27600	DONILLE D'ECARMENT
97	945328 00000	VIS HEXAGONALE INTERNE
98	949451 00000	RONDELLE
101	833903 99597	PLATEAU DE SOUPE
102	951906 00000	PROTECTION EN CAOUTCHOUC
103	068002 16500	TUBE D'ECARTEMENT
104	548800 16300	PITON
124	736000 99613	SOUPE REGLAGE VIDE
125	728002 99611	SOUPE REGLAGE PRESSION

¹⁾ quantité nécessaire / entretien

T 4.25DSK (1~) Fabrication - AC monophasé

Articles divergents vis-à-vis de l'appareil standard, voir annexe (dos du dessin / du plan)

EN OPTION



T 4.40DSK

Pos.	No. Identification	Designation
15	020000 16500	PISTON
16	016800 16500	DISQUE DE SERRAGE
17	911008 00000	BAGUE STAR
18	949203 00000	DENT DISQUE
19	945320 00000	VIS HEXAGONALE INTERNE
21	000100 27600	CORP DE POMPE
22	951806 00000	DOUILLE DE ETRAGE
23	945322 00000	VIS HEXAGONALE INTERNE
24	901352 00007	PALETTE DE CHARBON (KIT)
25	952009 00000	DOVILLE DE ETRAGE
28	000700 27600	COUVERCLE
29	945374 00000	VIS HEXAGONALE INTERNE
30	008900 16500	JOINT
31	948763 00000	GOUPILLE A ENCOCHE
32	953114 00000	BUSE
33	560200 27600	REFROIDISSEUR
34	005700 27600	JOINT
35	945325 00000	VIS HEXAGONALE INTERNE
46	902300 27600	VENTILATEUR
48	947713 00000	CLAVETTE
49	949454 00000	RONDELLE
50	901804 00000	VIS BOUT D'ARBRE
61	004803 27600	COUVERCLE DU FILTRE
67	009000 16300	RESSORT-JAME
72	909505 00000	CARTOUCHE FILTRANTE C 75/2 (1x) ¹⁾
73	909518 00000	CARTOUCHE FILTRANTE C 44 (1x) ¹⁾
74	909529 00000	CARTOUCHE FILTRANTE C78/6 (1x) ¹⁾
76	945373 00000	VIS HEXAGONALE INTERNE
77	948021 00000	JOINT
78	913161 00000	ANNEAU-O
83	006800 27600	CARTER PROTECTEUR
84	742609 01000	TUBE FLEXIBLE
85	951920 00000	ELEMENT EN CAOUTCHOUC
88	006803 27600	CARTER PROTECTEUR
89	741365 00000	AMORTISSEUR EN CAOUTCHOUC
90	945318 00000	VIS HEXAGONALE INTERNE
91	951922 00000	ELEMENT EN CAOUTCHOUC
92	964108 00000	PROTECTION D'ARETE
94	015100 27600	PIED
95	951921 00000	ELEMENT EN CAOUTCHOUC
96	068000 27600	DONILLE D'ECARMENT
97	945328 00000	VIS HEXAGONALE INTERNE
98	949451 00000	RONDELLE
101	833903 99597	PLATEAU DE SOUPE
102	951906 00000	PROTECTION EN CAOUTCHOUC
103	068002 16500	TUBE D'ECARTEMENT
104	548800 16300	PITON
124	736000 99613	SOUPE REGLAGE VIDE
125	728002 99611	SOUPE REGLAGE PRESSION

¹⁾ quantité nécessaire / entretien

T 4.40DSK (1~) Fabrication - AC monophasé

T 4.40DSK-34 (3~) Fabrication spéciale - avec excentricité agrandie

Articles divergents vis-à-vis de l'appareil standard, voir annexe (dos du dessin / du plan)

EN OPTION



T 4.25DSK

Pos.	No. Identificazione	Designazione
15	020000 16400	ROTORE
16	016800 16500	DISCO DI FISSAGGIO
17	911012 00000	STAR-ANELLO TOLLERANZA
18	949203 00000	DISCO A DENTE
19	945320 00000	VITE ESAGONALE INTERNA
21	000100 27500	CARASSA
22	951806 00000	SPINE DI RISCONTRO
23	945320 00000	VITE ESAGONALE INTERNA
24	901349 00007	PALETTE DI CHARBONE (KIT)
25	952009 00000	SPINE DI RISCONTRO
28	000700 27600	COPERCHIO
29	945373 00000	VITE ESAGONALE INTERNA
30	008900 16500	GUARNIZIONE
31	948763 00000	PERNO
32	953114 00000	UGGELLO
33	560200 27500	RAFFREDDATORE
34	005700 27600	GUARNIZIONE
35	945325 00000	VITE ESAGONALE INTERNA
46	502300 16400	VENTILATORE
48	947713 00000	CHIAVETTA
49	949454 00000	RONDELLA
50	901804 00000	VITE DI CHIUSURA ALBERO
61	004803 27600	COPERCHIO FILTRO
67	009000 16300	MOLLA
72	909505 00000	CARTUCCIA FILTRO C 75/2 (1x)¹⁾
73	909518 00000	CARTUCCIA FILTRO C 44 (1x)¹⁾
74	909529 00000	CARTUCCIA FILTRO C78/6 (1x)¹⁾
76	945373 00000	VITE ESAGONALE INTERNA
77	948021 00000	ANELLO GUARNIZIONE
78	913161 00000	ANELLO-O
83	006800 27500	CARTER DI PROTEZIONE
84	742609 01000	TUBO FLESSIBILE
85	951920 00000	ELEMENTO IN GOMMA
88	006803 27600	CARTER DI PROTEZIONE
89	741365 00000	AMMORTIZZATORE IN GOMMA
90	945318 00000	VITE ESAGONALE INTERNA
91	951922 00000	ELEMENTO IN GOMMA
92	964108 00000	LISTELLO DI PROTEZIONE
94	015100 27600	PIEDE
95	951921 00000	ELEMENTO IN GOMMA
96	068000 27600	BOCCOLA DISTANZIATRICE
97	945328 00000	VITE ESAGONALE INTERNA
98	949451 00000	RONDELLA
101	833903 99597	PIATELLO DELLA VALVOLA
102	951906 00000	PROTEZIONE IN GOMMA
103	068002 16500	TUBO DISTANZA
104	548800 16300	GANCIO
124	736000 99613	VALVOLA REGOLARE VUOTO
125	728002 99611	VALVOLA REGOLARE PRESSIONE

¹⁾ quantità di ordinazione necessari / manutenzione

T 4.25DSK (1~) Versión - AC monofásica

Vedere allegato (retro del disegno) per le posizioni divergenti dall'apparecchio standard

OPZIONALE



T 4.40DSK

Pos.	No. Identificazione	Designazione
15	020000 16500	ROTORE
16	016800 16500	DISCO DI FISSAGGIO
17	911008 00000	STAR-ANELLO TOLLERANZA
18	949203 00000	DISCO A DENTE
19	945320 00000	VITE ESAGONALE INTERNA
21	000100 27600	CARASSA
22	951806 00000	SPINE DI RISCONTRO
23	945322 00000	VITE ESAGONALE INTERNA
24	901352 00007	PALETTE DI CHARBONE (KIT)
25	952009 00000	SPINE DI RISCONTRO
28	000700 27600	COPERCHIO
29	945374 00000	VITE ESAGONALE INTERNA
30	008900 16500	GUARNIZIONE
31	948763 00000	PERNO
32	953114 00000	UGGELLO
33	560200 27600	RAFFREDDATORE
34	005700 27600	GUARNIZIONE
35	945325 00000	VITE ESAGONALE INTERNA
46	902300 27600	VENTILATORE
48	947713 00000	CHIAVETTA
49	949454 00000	RONDELLA
50	901804 00000	VITE DI CHIUSURA ALBERO
61	004803 27600	COPERCHIO FILTRO
67	009000 16300	MOLLA
72	909505 00000	CARTUCCIA FILTRO C 75/2 (1x)¹⁾
73	909518 00000	CARTUCCIA FILTRO C 44 (1x)¹⁾
74	909529 00000	CARTUCCIA FILTRO C78/6 (1x)¹⁾
76	945373 00000	VITE ESAGONALE INTERNA
77	948021 00000	ANELLO GUARNIZIONE
78	913161 00000	ANELLO-O
83	006800 27600	CARTER DI PROTEZIONE
84	742609 01000	TUBO FLESSIBILE
85	951920 00000	ELEMENTO IN GOMMA
88	006803 27600	CARTER DI PROTEZIONE
89	741365 00000	AMMORTIZZATORE IN GOMMA
90	945318 00000	VITE ESAGONALE INTERNA
91	951922 00000	ELEMENTO IN GOMMA
92	964108 00000	LISTELLO DI PROTEZIONE
94	015100 27600	PIEDE
95	951921 00000	ELEMENTO IN GOMMA
96	068000 27600	BOCCOLA DISTANZIATRICE
97	945328 00000	VITE ESAGONALE INTERNA
98	949451 00000	RONDELLA
101	833903 99597	PIATELLO DELLA VALVOLA
102	951906 00000	PROTEZIONE IN GOMMA
103	068002 16500	TUBO DISTANZA
104	548800 16300	GANCIO
124	736000 99613	VALVOLA REGOLARE VUOTO
125	728002 99611	VALVOLA REGOLARE PRESSIONE

¹⁾ quantità di ordinazione necessari / manutenzione

T 4.40DSK (1~) Modello - AC monofase

T 4.40DSK-34 (3~) Modello speciale - con eccentricità ingrandita

Vedere allegato (retro del disegno) per le posizioni divergenti dall'apparecchio standard

OPZIONALE



T 4.25DSK

Pos.	No. De pedido	Descripción	
15	020000 16400	ÉMBOLO	
16	016800 16500	ARANDELA TENSORA	
17	911012 00000	ANILLO DE TOLERANCIA STAR	
18	949203 00000	POLEA DENTADA	
19	945320 00000	TORNILLO HEXAGONAL INTERIOR	
21	000100 27500	CARCASA	
22	951806 00000	CASQUILLO TENSOR	
23	945320 00000	TORNILLO HEXAGONAL INTERIOR	
24	901349 00007	EMPUJADOR DE CARBÓN (KIT)	
25	952009 00000	CASQUILLO TENSOR	
28	000700 27600	TAPA LATERAL	
29	945373 00000	TORNILLO HEXAGONAL INTERIOR	
30	008900 16500	JUNTA	
31	948763 00000	CLAVO ESTRIADO	
32	953114 00000	TOBERA DE SILENCIADOR	
33	560200 27500	REFRIGERADOR	
34	005700 27600	JUNTA	
35	945325 00000	TORNILLO HEXAGONAL INTERIOR	
46	502300 16400	VENTILADOR	
48	947713 00000	LENGÜETA DE AJUSTE	
49	949454 00000	ARANDELA	
50	901804 00000	TORNILLO TERMINAL DE ÁRBOL	
61	004803 27600	TAPA DE FILTRO	
67	009000 16300	MUELLE DE PRESIÓN	
72	909505 00000	CARTUCHO DE FILTRO C 75/2 (1x)¹⁾	
73	909518 00000	CARTUCHO DE FILTRO C 44 (1x)¹⁾	
74	909529 00000	CARTUCHO DE FILTRO C78/6 (1x)¹⁾	
76	945373 00000	TORNILLO HEXAGONAL INTERIOR	
77	948021 00000	ANILLO DE JUNTA	
78	913161 00000	JUNTA TÓRICA	
83	006800 27500	CAPERUZA DE APARATO	
84	742609 01000	MANGUERA	
85	951920 00000	PIEZA DE ORMA DE GOMA	
88	006803 27600	CAPERUZA DE APARATO	
89	741365 00000	AMORTIGUADOR DE GOMA	
90	945318 00000	TORNILLO HEXAGONAL INTERIOR	
91	951922 00000	PIEZA DE ORMA DE GOMA	
92	964108 00000	PROTECCIÓN DE CANTOS	
94	015100 27600	PIE	
95	951921 00000	PIEZA DE ORMA DE GOMA	
96	068000 27600	PIEZA DISTANCIADORA	
97	945328 00000	TORNILLO HEXAGONAL INTERIOR	
98	949451 00000	ARANDELA	
101	833903 99597	PLATILLO DE VÁLVULA	
102	951906 00000	BOQUILLA DE CABLE	
103	068002 16500	TUBO DISTANCIADOR	
104	548800 16300	TORNILLO DE CÁNCAMO	
124	736000 99613	VÁLVULA REGULADORA DE VACÍO	
125	728002 99611	VÁLVULA REGULADORA DE PRESIÓN	

¹⁾ cantidad necesario / mantenimiento

T 4.25DSK (1~) Versión - AC monofásica

Para posiciones que derivan del aparato standard véase apéndice (lado trasero del plano)

OPCIONAL



T 4.40DSK

Pos.	No. De pedido	Descripción	
15	020000 16500	ÉMBOLO	
16	016800 16500	ARANDELA TENSORA	
17	911008 00000	ANILLO DE TOLERANCIA STAR	
18	949203 00000	POLEA DENTADA	
19	945320 00000	TORNILLO HEXAGONAL INTERIOR	
21	000100 27600	CARCASA	
22	951806 00000	CASQUILLO TENSOR	
23	945322 00000	TORNILLO HEXAGONAL INTERIOR	
24	901352 00007	EMPUJADOR DE CARBÓN (KIT)	
25	952009 00000	CASQUILLO TENSOR	
28	000700 27600	TAPA LATERAL	
29	945374 00000	TORNILLO HEXAGONAL INTERIOR	
30	008900 16500	JUNTA	
31	948763 00000	CLAVO ESTRIADO	
32	953114 00000	TOBERA DE SILENCIADOR	
33	560200 27600	REFRIGERADOR	
34	005700 27600	JUNTA	
35	945325 00000	TORNILLO HEXAGONAL INTERIOR	
46	902300 27600	VENTILADOR	
48	947713 00000	LENGÜETA DE AJUSTE	
49	949454 00000	ARANDELA	
50	901804 00000	TORNILLO TERMINAL DE ÁRBOL	
61	004803 27600	TAPA DE FILTRO	
67	009000 16300	MUELLE DE PRESIÓN	
72	909505 00000	CARTUCHO DE FILTRO C 75/2 (1x)¹⁾	
73	909518 00000	CARTUCHO DE FILTRO C 44 (1x)¹⁾	
74	909529 00000	CARTUCHO DE FILTRO C78/6 (1x)¹⁾	
76	945373 00000	TORNILLO HEXAGONAL INTERIOR	
77	948021 00000	ANILLO DE JUNTA	
78	913161 00000	JUNTA TÓRICA	
83	006800 27600	CAPERUZA DE APARATO	
84	742609 01000	MANGUERA	
85	951920 00000	PIEZA DE ORMA DE GOMA	
88	006803 27600	CAPERUZA DE APARATO	
89	741365 00000	AMORTIGUADOR DE GOMA	
90	945318 00000	TORNILLO HEXAGONAL INTERIOR	
91	951922 00000	PIEZA DE ORMA DE GOMA	
92	964108 00000	PROTECCIÓN DE CANTOS	
94	015100 27600	PIE	
95	951921 00000	PIEZA DE ORMA DE GOMA	
96	068000 27600	PIEZA DISTANCIADORA	
97	945328 00000	TORNILLO HEXAGONAL INTERIOR	
98	949451 00000	ARANDELA	
101	833903 99597	PLATILLO DE VÁLVULA	
102	951906 00000	BOQUILLA DE CABLE	
103	068002 16500	TUBO DISTANCIADOR	
104	548800 16300	TORNILLO DE CÁNCAMO	
124	736000 99613	VÁLVULA REGULADORA DE VACÍO	
125	728002 99611	VÁLVULA REGULADORA DE PRESIÓN	

¹⁾ cantidad necesario / mantenimiento

T 4.40DSK (1~) Versión - AC monofásica

T 4.40DSK-34 (3~) Versión especial - con excentricidad ampliada

Para posiciones que derivan del aparato standard véase apéndice (lado trasero del plano)

OPCIONAL

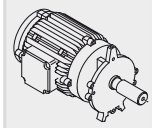

SERVICE ?

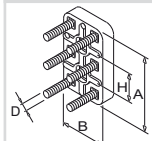
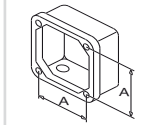
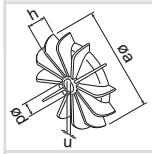

1~

C = ? μ F
U = ? V

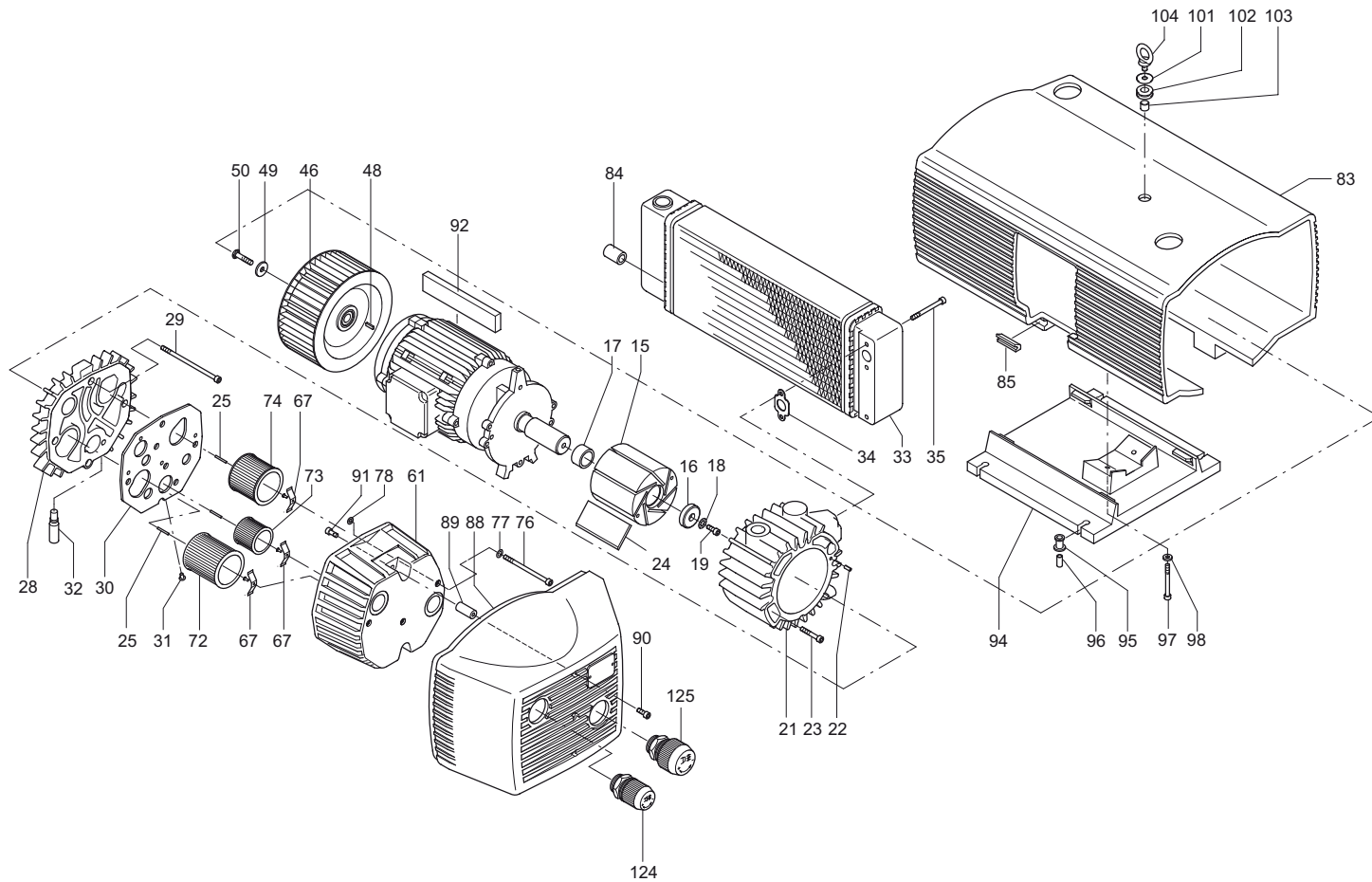
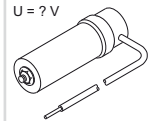

standard

T 4.25DSK (3~)

T 4.40DSK (3~)

optional
en option
opcionale
opcional

optional en option optionale opcional 	Variante(n) Modifications Variantes	Pos ²⁾	Bestell Nr. / Ident No. / No. Identification / No. Identificazione / No. De pedido		Beschreibung / Description / Designation / Designazione / Desripcion
			+	-	
T 4.25DSK (1~)	T 4.25DSK (1~)	8	964233 00000		WINKEL / BRACKET / COUDES / GOMITO / ÁNGULO BLINDNIET / BLIND RIVET / RIVET AVEUGLIE / RIVETTO CIECO / REMACHE CIEGO KABEL / CABLE / CABLE / CAVO / CABLE T 4.25DSK - HAUBE / PROTECTING HOOD / CARTER PROTECTEUR / CARTER DI PROTEZIONE / CAPERUZA T 4.40DSK - HAUBE / PROTECTING HOOD / CARTER PROTECTEUR / CARTER DI PROTEZIONE / CAPERUZA FUSS / FOOT / PIED / PIEDE / PIE
	T 4.40DSK (1~)	12	948766 00000		
		13	742002 30000		
		83	006802 27500	006800-27500	
		83	006804 27600	006800-27600	
	94	015101 27600	045100-27600		
T 4.40DSK (1~) T 4.40DSK-34 (3~)	T 4.40DSK-34 (3~)	21	000101 27600	000100-27600	GEHÄUSE / PUMP BODY / CORP DE POMPE / CARCASSA / CARCASA

²⁾ variantenabhängige Bauteile / variant-dependent components / composants variante-dependantes / componenti variante-dispendenti / componentes variante-dependientes



standard